



Registering your appliance is quick and easy at www.prodregister.com/foodsaver. If you register on our website, you will have the opportunity to receive special bag and accessory introductory offers. Refer to the registration card inside the box.

For important safety information and helpful tips, please visit us at www.foodsaver.com to get tips on vacuum sealing and order FoodSaver® brand accessories, bags and rolls, or call 1-877-777-8042 (U.S.).



User Manual & Recipe Book for V3800 series appliances

©2010 Sunbeam Products, Inc. doing business as Jarden Consumer Solutions. All rights reserved. Distributed by Sunbeam Products, Inc. doing business as Jarden Consumer Solutions, Boca Raton, Florida 33431.

Printed in China.

P.N. 140089

www.foodsaver.com 1-877-777-8042

Important Safeguards & Tips

Important Safeguards

For your own safety, always follow these basic precautions when using a FoodSaver® appliance:

1. Read the User Manual carefully for operating instructions. Read all instructions in this manual before use.
2. Do not use appliance on wet or hot surfaces, or near a heat source.
3. To protect against electric shock, do not immerse any part of appliance, power cord or plug in water or other liquid. Unplug from outlet when not in use and before cleaning.
4. To disconnect, unplug power cord from electrical outlet. Do not disconnect by pulling on cord.
5. Do not operate appliance with a damaged power cord or plug. Do not operate appliance if it malfunctions or is in any way damaged. For details, contact Consumer Services at number listed below.
6. Use appliance only for its intended use.
7. Closely supervise children when using any electrical appliance. Do not allow appliance to be used as a toy.
8. 120v Appliances Only: The FoodSaver® appliance has a polarized plug (one blade is wider than the other). To reduce risk of electrical shock, this plug is intended to fit in a polarized outlet only one way. If plug does not fit fully in the outlet, reverse plug. If it still does not fit, contact a qualified electrician. Do not modify plug in any way.
9. Caution: A short power cord is provided to reduce risks from entanglement or tripping over a longer cord. An extension cord may be used when marked electrical rating is no less than electrical rating of this appliance. All cords should not drape over counter or tabletop where cords can be tripped over or pulled on unintentionally, especially by children.
10. Do not place on or near a hot gas or electric burner, or heated oven. Extreme caution must be used when moving products containing hot liquids.
11. Wait 20 seconds between seals to allow appliance to cool.

**For Household Use Only
SAVE THESE INSTRUCTIONS**

Important Tips

1. Vacuum packaging is NOT a substitute for the heat process of canning. Perishables still need to be refrigerated or frozen.
2. For best results, use only with FoodSaver® Bags, Containers and Accessories.
3. During the vacuum packaging process, small amounts of liquids, crumbs or food particles can be inadvertently pulled into the Vacuum Channel. Empty the Drip Tray after each use.
4. Avoid overfilling, always leave at least 3 inches of bag material between bag contents and top of bag. This allows room for the bag material to cinch tightly against the food and prevents the bag from pulling out of the vacuum channel during the sealing process. Then leave at least one additional inch of bag material for each time you plan to reuse bag.
5. Do not create your own side seams for a FoodSaver® Bag. These bags are manufactured with a special side seam, which is sealed all the way to the outer edge.
6. To prevent wrinkles in the seal when vacuum packaging bulky items, gently stretch bag flat while inserting bag into vacuum channel and continue to hold bag until vacuum pump starts.
7. When you are vacuum packaging items with sharp edges (dry spaghetti, silverware, etc.), protect bag from punctures by wrapping item in soft cushioning material, such as a paper towel. You may want to use a canister or Mason jar instead of a bag.
8. When using accessories, remember to leave one inch of space at top of canister or container.
9. Pre-freeze fruits and blanch vegetables before vacuum packaging for best results. See guidelines for Vacuum Packaging Section.

This appliance has a polarized plug (one blade is wider than the other). As a safety feature, this plug will fit in a polarized outlet only one way. If the plug does not fit fully in the outlet, reverse the plug. If it still does not fit, contact a qualified electrician. Do not attempt to defeat this safety feature.

Welcome to FoodSaver® Vacuum Sealing System

Congratulations...

You are about to enjoy the freshness benefits of FoodSaver®, The #1 Selling Brand of Vacuum Packaging Systems. For years, the FoodSaver® Vacuum Packaging System has helped millions of households keep food fresh longer in the refrigerator, freezer and pantry. The FoodSaver® system is designed to remove air and extend freshness up to five times longer than conventional storage methods. Keep your FoodSaver® appliance on your countertop, and you'll soon discover its convenience and versatility.

Free Gift with Registration!

Register now and you'll receive a free gift. It's our "thanks" to you for being a FoodSaver® customer.

Register online at www.foodsaver.com/register. You'll have access to special sale items for online registrants only!

Questions?

Contact customer service at

877-777-8042

or visit www.foodsaver.com.

**Do not return this product
to place of purchase.**

Features of Your FoodSaver® Appliance

FEATURES



- A. Controls and Indicator Lights**
Indicate current setting and vacuum progress for added control.
- B. Vacuum Progress Display**
Blue lights signal progression of vacuuming and sealing process. All lights extinguish when the full process is finished.
- C. Seal/Stop Button**
CrushFree™ Instant Seal feature. Stops vacuum cycle and seals to prevent crushing delicate items.
- D. Appliance Door**
Opens to access Built-in Roll Holder and Cutter.
- E. Vacuum Channel**
Simply insert bag and the FoodSaver® appliance does the rest.
- F. Retractable Accessory Hose/ Accessory Port**
Accessory hose can be used with all FoodSaver® Brand Accessories.
- G. Integrated Bag Opener**
Quick and convenient, opens sealed bags with ease.
- H. Power Cord Storage**
At bottom of unit.



- H. Built-in Roll Holder**
For storage of FoodSaver® Vacuum Sealing Rolls.
- I. Roll Cutter**
Simplifies making custom-sized bags.
- J. Auto Bag Sensing**
Simply insert open end of bag into the vacuum channel and the machine will sense and grasp the bag, vacuum, seal and shut-off automatically.
- K. Release Buttons**
To open appliance for cleaning.
- L. Appliance Door**
Opens to access Built-in Roll Holder and Cutter.



- M. Lower Gasket**
- N. Extra-wide Sealing Strip with Non-stick Coating**
Provides extra secure, airtight seal that's two times wider.
- O. Drip Tray**
Catches overflow liquids and contains Food Sensors to detect liquid.
- P. Upper Bag Detection Tray**
- Q. Upper Foam Gasket (not removable)**
- R. Rubber Seal Profile**

FEATURES

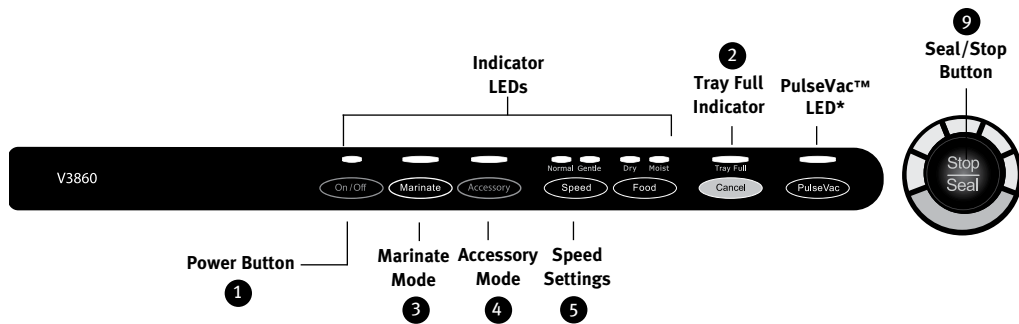

1 POWER BUTTON

Press the power button to begin. The Power Indicator, Speed Indicator and Food Indicator lights will become illuminated. After Vacuum Sealing, press Power Button to turn appliance Off.

Note: After 12 minutes, the appliance will turn Off automatically.

2 TRAY FULL INDICATOR LIGHT

During the vacuum sealing process, small amounts of liquids, crumbs or food particles can be inadvertently pulled into the Drip Tray (O). When excess liquid fills the Drip Tray, the unit will turn off and the Tray Full Indicator (2) will activate. To resume normal operation, remove the Drip Tray, empty liquid, wash in warm soapy water or place in top rack of dishwasher. Dry and replace Drip Tray in trough. (See Care and Cleaning)

3 MARINATE MODE BUTTON

A ten minute predetermined sequence of vacuum pulse to rest ratio allowing foods to get optimum flavor infusion in the least amount of time. See “Marinating with your FoodSaver® Appliance” section on page 16.

4 ACCESSORY MODE BUTTON

Press to achieve best vacuum for canisters and accessories. Push Accessory Vacuum Button (4) to begin vacuum process. Motor will run until Vacuum Sealing Process is complete.

5 SPEED SETTINGS BUTTON

When vacuum sealing delicate items, press Speed Setting Button (5) so that the gentle speed indicator light is illuminated. For more control you may press Seal/Stop Button (9) at any time to stop vacuum and begin automatic sealing process. **Note:** Appliance will default to Normal speed upon pressing the Power On Button or when power has been interrupted.

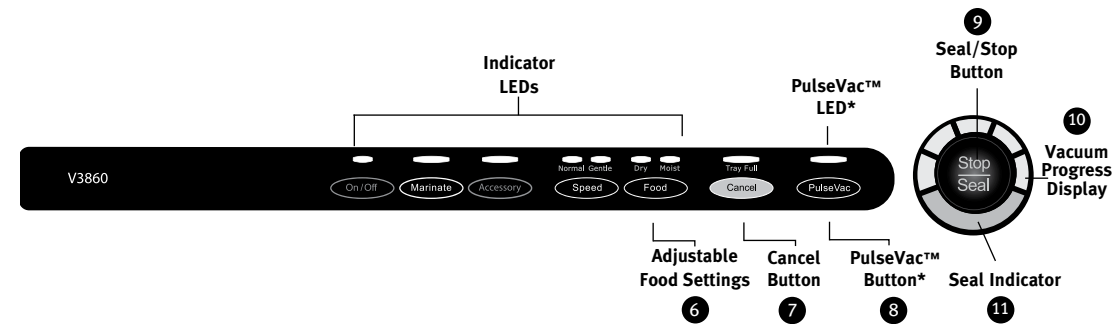

6 ADJUSTABLE FOOD SETTINGS BUTTON

For optimal vacuuming and sealing of moist or juicy foods, press the Adjustable Food Setting Button (6) until the Moist Indicator Light is illuminated. Choose the dry food setting for foods without liquid.

The Moist Food Indicator light will flash when Food Sealing Sensors automatically detect any moisture or liquid in the drip tray (O).

Note: Appliance will default to Dry setting upon pressing the Power Button or when power has been interrupted, unless liquid is detected in the Drip Tray. (See Care and Cleaning section of this User Manual).

7 CANCEL BUTTON

Immediately halts the current function opening the Vacuum Channel.

8 PAUSE OR PulseVac™ CONTROL BUTTON

(*not available on all models)

Use to manually control the vacuum process and avoid crushing delicate items. See tips section for further information.

9 SEAL/STOP BUTTON

CrushFree™ Instant Seal feature-

This button has four uses:

1. Press to immediately stop the vacuum process and begin sealing the bag. This prevents crushing delicate items such as bread, cookies and pastries.
2. Press to create a seal when making bags from a FoodSaver® Roll.
3. Press to create a seal on Mylar bags (such as a potato chip bag) to keep food sealed airtight.
4. Press during PulseVac™ mode to seal bag.

10 VACUUM PROGRESS DISPLAY

Displays vacuum levels as the bag/canister is evacuated.

11 SEAL INDICATOR LIGHT

Constant Red light indicates sealing process is engaged. (Flashing light indicates error)

Removing Air from a Bag

Avoid wrinkles when inserting the bag into the Vacuum Channel (E).

Wrinkles in seal may cause leakage and allow air to return into bag. To eliminate any wrinkles while inserting bag, curl down into the vacuum channel (E), hold bag with two hands gently stretching bag flat until vacuum pump begins. If you find wrinkles after sealing bag, simply cut bag open and vacuum seal again.

If motor runs for more than 30 seconds without stopping, consider the following:

If you are vacuum sealing with a bag, make sure the bag is properly sealed (See “How to Make a Bag From a Roll”). Check foam gasket around Upper Bag Detection Tray to make sure it is free from food material. Do not attempt to remove gasket.

If vacuum sealing with an accessory, check Accessory Hose connections to ensure a tight fit.

FoodSaver® Vacuum Sealing Accessories

Accessory Hose Reel

1. Prepare container according to FoodSaver® Accessory Guidelines.
2. Pull Accessory Hose (F) from appliance and insert the end into the port on accessory. Twist tab while inserting to ensure a tight fit.
3. Push Accessory Vacuum Button (4) to begin vacuum process. Motor will run until vacuum process is complete. (To Marinate, follow instructions found in Marinate Button section of this Guide).
4. When motor turns off, gently twist and remove Accessory Hose from accessory.
5. To test vacuum, simply tug on accessory lid. It should not move.
6. To retract accessory hose, while holding unit, gently pull on hose end to allow hose to retract into appliance housing. Do not release freely as it may damage the hose tip.

Important: When pulling hose Do Not extend beyond green circle marked on hose.

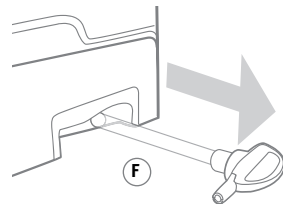

Note: if you are using a canister with large white knob, rotate knob clockwise to the “Closed” position, then gently twist and remove Accessory Hose from accessory.

Using PulseVac™ Control Feature

(This special feature is not available on all V3800 models)

Use the PulseVac™ Control feature to manually control the vacuum process and avoid crushing delicate items.

1. Place item(s) in bag, allowing at least 3 inches (7.62 centimeters) of space between bag contents and top of bag.
2. Press the PulseVac™ button (8). PulseVac™ LED will flash to indicate PulseVac™ mode.
3. Press appropriate Speed Setting Button (5) – Normal or Gentle.
4. Insert open end of bag into Vacuum Channel (J). The clamp will close to secure the bag.

5. Push and hold the PulseVac™ Button (8). The vacuum pump will run when the PulseVac™ Button is held down. Release the PulseVac™ Button to stop the vacuum process. This will allow you to adjust the contents of the bag for better control of the vacuum sealing process. Repeat pushing the PulseVac™ Button until desired amount of air has been removed.
NOTE: If the vacuum pump stops engaging after several pushes of the PulseVac™ Button, it means the maximum vacuum has been reached. Do not continue to push the PulseVac™ Button.
6. Press Seal/Stop Button (9) to seal the bag and end the PulseVac™ mode.
7. When the red Seal Indicator Light (11) turns off, remove bag. Refrigerate or freeze if needed.

Using the Integrated Bag Opener

The Bag Opener is a handy and convenient way to open sealed bags.

To Use:

1. Press Bag Opener to extend (See Fig. 1) (press again to retract Bag Opener for storage).
2. Fold end of bag to create a loop (as shown in Fig.2) with the sealed bag so the Heat Sealed area is above the cutter.
3. Hold bag taught with two hands and pull bag through the cutter (See Fig. 3).

Note: Bags that previously contained fruits, vegetable and dry goods can be resealed. Bags that contained raw meats, fish, eggs or unpasteurized cheese should be discarded after use because they may contain invisible bacteria that will remain after washing.

PRESS BAG OPENER

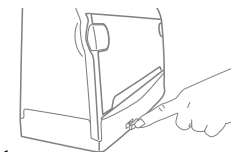

Fig. 1

FOLD BAG & PULL THROUGH CUTTER

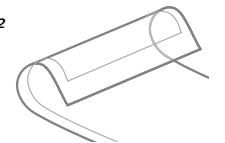

Fig. 2

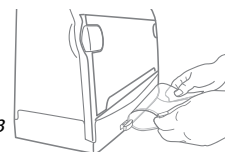

Fig. 3

How to Make a Bag from a FoodSaver® Vacuum Sealing Roll

1. Open appliance door (Fig. 1) and place roll into Roll Storage Compartment (H) (Fig. 2).

For Best results, insert roll with material flap down.

Note: Bags can be sealed with appliance door either open or closed.

2. Lift up Bag Cutter Bar (i) and place bag material beneath the cutter bar (Fig. 3).

3. Pull out enough bag material to hold item being vacuum packed, plus 4 inches (10.16 centimeters). Lower the Cutter Bar and slide Bag Cutter (i) across the Cutter Bar (Fig. 4).

4. Press Seal/Stop Button (C). Red seal light will illuminate (Fig. 5).

5. Using two hands, insert open end of bag, curl down, into Vacuum Channel (E) until clamp motor starts. Bag must be centered between arrows. (Vacuum Channel can operate with door opened or closed).

6. When red seal light (11) turns off, sealing is complete. You may remove bag from the Vacuum Channel (E).

7. You now have one sealed end. (Fig. 6).

8. Now you are ready to vacuum seal with your new bag (See next page).

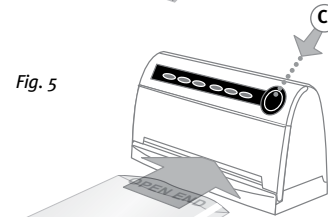
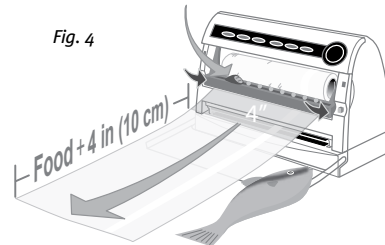
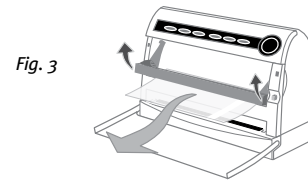
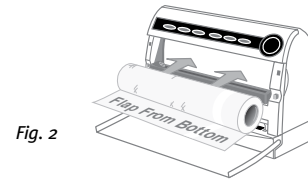
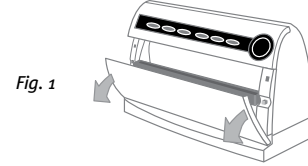

How to Vacuum Seal with FoodSaver® Vacuum Sealing Bags

1. Begin with a FoodSaver® Vacuum Sealing System Bag (or create a bag as described in the “How to Make a Bag from a Roll” section).

2. Place item(s) in bag, allowing at least 3 inches (7.62cm) of space between bag contents and top of bag (Fig. 1). The extra space is required to allow the bag to seal tightly around contents.

3. OPTIONAL: If you wish to customize the vacuum sealing process you may select Speed setting (5) and Food Setting (6) (Fig. 2). Default setting is Normal Speed and Dry Food. See page 5 and 6 for more information.

4. Your new FoodSaver® System Automatically Vacuums and Seals. **To Vacuum: DO NOT PRESS THE STOP/SEAL BUTTON.** Using two hands, insert open end of bag, curl down, into Vacuum Channel (E) (Fig. 3/4).

5. Continue to hold bag until vacuum pump starts. You may now release bag. The Vacuum Progress lights (11) will illuminate. **Note:** To prevent crushing delicate items, you may now press Seal/Stop Button (C) at any time to begin automatic sealing process.

6. When red Seal Light (11) turns off, remove bag (Fig. 5). Refrigerate or freeze if needed.

- Note:** Wait at least 20 seconds between seals to allow appliance to properly cool.

See www.foodsaver.com for additional hints, tips, instructional videos and information about how to purchase FoodSaver® parts and accessories like the Pre-cut Bag Storage.

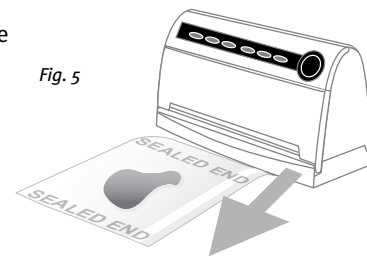
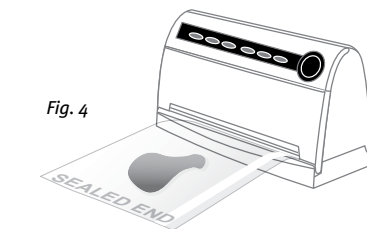
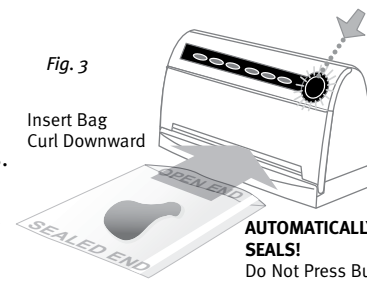
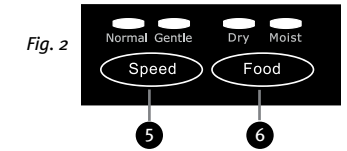
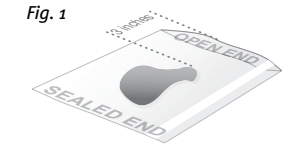

Guidelines for Vacuum Packaging

Vacuum Packaging and Food Safety

The vacuum packaging process extends the life of foods by removing most of the air from the sealed container, thereby reducing oxidation, which affects nutritional value, flavor and overall quality. Removing air can also inhibit growth of microorganisms, which can cause problems under certain conditions:

Mold – Easily identified by its fuzzy characteristic. Mold cannot grow in a low oxygen environment, therefore vacuum packaging can slow the growth of mold.

Yeast – Results in fermentation, which can be identified by smell and taste. Yeast needs water, sugar and a moderate temperature to grow. It can also survive with or without air. Slowing the growth of yeast requires refrigeration, while freezing stops it completely.

Bacteria – Results in an unpleasant odor, discoloration and/or soft or slimy texture. Under the right conditions, anaerobic bacteria such as Clostridium botulinum (the organism that causes Botulism) can grow without air and sometimes cannot be detected by smell or taste. Although it is extremely rare, it can be very dangerous.

To preserve foods safely, it is critical that you maintain low temperatures. You can significantly reduce the growth of microorganisms at temperatures of 40°F (4°C) or below. Freezing at 0°F (-17°C) does not kill microorganisms, but stops them from growing. For long-term storage, always freeze perishable foods that have been vacuum packaged, and keep refrigerated after thawing.

It is important to note that vacuum packaging is NOT a substitute for canning and it cannot reverse the deterioration of foods. It can only slow down the changes in quality. It is difficult to predict how long foods will retain their top-quality flavor, appearance or texture because it depends on age and condition of the food on the day it was vacuumed packaged.

IMPORTANT: Vacuum packaging is NOT a substitute for refrigeration or freezing. Any perishable foods that require refrigeration must still be refrigerated or frozen after vacuum packaging.

Food Preparation and Reheating Tips

Thawing and Reheating Vacuum Packaged Foods

Always thaw foods in either refrigerator or microwave — do not thaw perishable foods at room temperature.

To reheat foods in a microwave in a FoodSaver® Bag, always cut corner of the bag before placing it on a microwave-safe dish. However, to avoid hot spots, do not reheat bone-in meat or greasy foods in microwave within a FoodSaver® Bag. You can also reheat foods in FoodSaver® Bags by placing them in water at a low simmer below 170°F (75°C).

Preparation Guidelines for Meat and Fish:

For best results, pre-freeze meat and fish for 1-2 hours before vacuum packaging in a FoodSaver® Bag. This helps retain the juice and shape, and guarantees a better seal.

If it's not possible to pre-freeze, place a folded paper towel between meat or fish and top of bag, but below seal area. Leave paper towel in bag to absorb excess moisture and juices during vacuum packaging process.

Note: Beef may appear darker after vacuum packaging due to the removal of oxygen. This is not an indication of spoilage.

Preparation Guidelines for Hard Cheeses:

To keep cheese fresh, vacuum package it after each use. Make your FoodSaver® Bag extra long, allowing one inch of bag material for each time you plan to open and reseal in addition to the 3-inch room you normally leave between contents and seal. Simply cut sealed edge and remove cheese. When you're ready to repack the cheese, just drop it in bag and reseal.

IMPORTANT: Due to the risk of anaerobic bacteria, Soft cheeses should never be vacuum packaged.

Preparation Guidelines for Vegetables:

Vegetables need to be blanched before vacuum packaging. This process stops the enzyme action that could lead to loss of flavor, color and texture.

To blanch vegetables, place them in boiling water or in the microwave until they are cooked, but still crisp. Blanching times range from 1 to 2 minutes for leafy greens and peas; 3 to 4 minutes for snap peas, sliced zucchini or broccoli; 5 minutes for carrots; and 7 to 11 minutes for corn on the cob. After blanching, immerse vegetables in cold water to stop the cooking process. Finally, dry vegetables on a towel before vacuum packaging.

Note: All vegetables (including broccoli, brussels sprouts, cabbage, cauliflower, kale, turnips) naturally emit gases during storage. Therefore, after blanching, they must be stored in freezer only.

When freezing vegetables, it is best to pre-freeze them for 1-2 hours or until solidly frozen. To freeze vegetables in individual servings, first place on a baking sheet and spread them out so they are not touching. This prevents them from freezing together in a block. Once they are frozen, remove from baking sheet and vacuum package vegetables in a FoodSaver® Bag. After they have been vacuum packaged, return them to the freezer.

IMPORTANT: Due to the risk of anaerobic bacteria, Fresh mushrooms, onions, & garlic should never be vacuum packaged.

Preparation Guidelines for Leafy Vegetables:

For best results, use a canister to store leafy vegetables. First wash the vegetables, and then dry with a towel or salad spinner. After they are dried, put them in a canister and vacuum package. Store in refrigerator.

Preparation Guidelines for Fruits:

When freezing soft fruits or berries, it is best to pre-freeze them for 1-2 hours or until solidly frozen. To freeze fruit in individual servings, first place on a baking sheet and spread them out so they are not touching. This prevents them from freezing together in a block. Once they are frozen, remove from baking sheet and vacuum package fruit in a FoodSaver® Bag. After they have been vacuum packaged, return them to the freezer.

You can vacuum package portions for baking, or in your favorite combinations for easy fruit salad all year round. If storing in the refrigerator, we recommend using a FoodSaver® Canister.

Preparation Guidelines for Baked Goods:

To vacuum package soft or airy baked goods, we recommend using a FoodSaver® Canister so they will hold their shape. If using a bag, pre-freeze for 1-2 hours or until solidly frozen. To save time, make cookie dough, pie shells, whole pies, or mix dry ingredients in advance and vacuum package for later use.

Preparation Guidelines for Coffee and Powdery Foods:

To prevent food particles from being drawn into vacuum pump, place a coffee filter or paper towel at top of bag or canister before vacuum packaging. You can also place the food in its original bag inside a FoodSaver® Bag, or use a FoodSaver® Universal Lid with the original container to vacuum package.

Preparation Guidelines for Liquids:

Before you vacuum package liquids such as soup stock, pre-freeze in a casserole dish, loaf pan or ice cube tray until solid. Remove frozen liquid from pan and vacuum package in a FoodSaver® Bag. You can stack these “frozen bricks” in your freezer. When you're ready to use, just cut corner of bag and place in a dish in microwave or drop into water at a low simmer, below 170°F (75°C).

To vacuum package non-carbonated bottled liquids, you can use a FoodSaver® Bottle Stopper with the original container. Remember to leave at least one inch of room between contents and bottom of Bottle Stopper. You can re-seal bottles after each use.

Preparation Guidelines for Make-ahead Meals, Leftovers and Sandwiches:

Efficiently store your make-ahead meals, leftovers and sandwiches in the stackable, lightweight FoodSaver® containers. They are microwaveable, top rack dishwasher safe and come with a custom adaptor. The lightweight containers will be ready to head off to the office or school when you are!

Preparation Guidelines for Snack Foods:

Your snack foods will maintain their freshness longer when you vacuum package them. For best results, use a FoodSaver® Canister for crushable items like crackers.

Vacuum Packaging Non-Food Items

The FoodSaver® vacuum packaging system also protects non-food items from oxidation, corrosion and moisture. Simply follow the directions to vacuum package items using FoodSaver® Bags, Canisters and Accessories.

To vacuum package silver, wrap fork tines in soft cushioning material, such as a paper towel, to avoid puncturing bag. Your FoodSaver® Bags are ideal for outdoor excursions. For camping and hiking, keep your matches, maps and food dry and compact. To have fresh water for drinking, simply fill a FoodSaver® Bag with ice, seal it and when needed, let the ice pack melt. If you're going sailing or boating, vacuum package your food, film and a dry change of clothes. Just remember to bring scissors or a knife to open the bag.

To keep emergency kits safe and dry, vacuum package flares, batteries, flashlights, matches, candles and other necessities. Your emergency items will stay dry and organized in your home, car or boat.

Storage Guide Meat, Cheese, Vegetables, Fruits

Foods	Where to Store	Recommended FoodSaver® Bag/Accessory	Storage Life with FoodSaver®	Normal Storage Life
Meat				
Beef, Pork, Lamb	Freezer	FoodSaver® Bag	2-3 years	6 months
Ground Meat	Freezer	FoodSaver® Bag	1 year	4 months
Poultry	Freezer	FoodSaver® Bag	2-3 years	6 months
Fish	Freezer	FoodSaver® Bag	2 years	6 months
Hard Cheeses (Do not vacuum package soft cheese)				
Cheddar, Swiss	Refrigerator	FoodSaver Bag, Canister	4-8 months	1-2 weeks
Parmesan	Refrigerator	FoodSaver® Bag, Canister	4-8 months	1-2 weeks
Vegetables (Do not vacuum package fresh mushrooms, onions & garlic)				
Asparagus	Freezer	FoodSaver® Bag	2-3 years	8 months
Broccoli, Cauliflower	Freezer	FoodSaver® Bag	2-3 years	8 months
Cabbage, Brussels Sprouts	Freezer	FoodSaver® Bag	2-3 years	8 months
Corn (cob or kernel)	Freezer	FoodSaver® Bag	2-3 years	8 months
Green Beans	Freezer	FoodSaver® Bag	2-3 years	8 months
Lettuce, Spinach	Refrigerator	FoodSaver® Canister	2 weeks	3-6 days
Snow Peas, Snap Peas	Freezer	FoodSaver® Bag	2-3 years	8 months
Fruits				
Apricots, Plums	Freezer	FoodSaver® Bag	1-3 years	6-12 months
Peaches, Nectarines	Freezer	FoodSaver® Bag	1-3 years	6-12 months
Softer Berries				
Raspberries, Blackberries	Refrigerator	FoodSaver® Canister	1 week	1-3 days
Strawberries	Refrigerator	FoodSaver® Canister	1 week	1-3 days
Harder Berries				
Blueberries	Refrigerator	FoodSaver® Canister	2 weeks	3-6 days
Cranberries	Refrigerator	FoodSaver® Canister	2 weeks	3-6 days
Huckleberries	Refrigerator	FoodSaver® Canister	2 weeks	3-6 days

Baked Goods, Coffee, Snacks and Liquids

Foods	Where to Store	Recommended FoodSaver® Bag/Accessory	Storage life with FoodSaver®	Normal Storage Life
Baked Goods				
Bagels, Bread, Pastries	Freezer	FoodSaver® Bag	1-3 years	6-12 months
Nuts				
Almonds, Peanuts	Pantry	FoodSaver® Bag, Canister	2 years	6 months
Sunflower Seeds	Pantry	FoodSaver® Bag, Canister	2 years	6 months
Coffee				
Coffee Beans	Freezer	FoodSaver® Bag	2-3 years	6 months
Coffee Beans	Pantry	FoodSaver® Bag, Canister	1 year	3 months
Ground Coffee	Freezer	FoodSaver® Bag	2 years	6 months
Ground Coffee	Pantry	FoodSaver® Bag, Canister	5-6 months	1 month
Prepared Liquids				
Sauces, Soups, Stews	Freezer	FoodSaver® Bag	1-2 years	3-6 months
Bottled Liquids				
Oils	Pantry	FoodSaver® Bottle Stopper	1-1½ years	5-6 months
Dry Foods				
Beans, Grains	Pantry	FoodSaver® Bag, Canister	1-2 years	6 months
Pasta, Rice	Pantry	FoodSaver® Bag, Canister	1-2 years	6 months
Powdery Foods				
Dry Milk	Pantry	FoodSaver® Bag, Canister	1-2 years	6 months
Dried Coconut	Pantry	FoodSaver® Bag, Canister	1-2 years	6 months
Flour	Pantry	FoodSaver® Bag, Canister	1-2 years	6 months
Sugar, Brown Sugar	Pantry	FoodSaver® Bag, Canister	1-2 years	6 months
Snack Foods				
Chips	Pantry	FoodSaver® Canister	3-6 weeks	1-2 weeks
Cookies, Crackers	Pantry	FoodSaver® Canister	3-6 weeks	1-2 weeks

Care and Cleaning

To Clean Appliance:

Press Stop and remove Power Cord from electrical outlet. Do not immerse in liquid.

Open appliance door (D), while holding the appliance with two hands, press two Release Buttons (K) with your thumbs, rotate appliance away from you, and allow appliance to rest on the counter. After cleaning, hold appliance with two hands and rotate upright until the latches lock.

Check Gasket (M) around Drip Tray (O) and Upper Foam Gasket (Q) which surrounds the Upper Bag Detection Tray (P) to make sure they are free from food materials. Do not attempt to remove gaskets.

Antibacterial Drip Tray & Upper Bag Detection Tray:

Empty Drip Tray after each use. Wash in warm soapy water or place in top rack of dishwasher. The Food Sensors in the Drip Tray (O) will not function correctly if liquid is allowed to remain in Drip Tray.

This appliance has a Tray Full indicator ②. When excess liquid fills the Drip Tray, the unit will turn off and the Tray Full Indicator light will activate. To resume normal operation, open Appliance Door (D), press two release buttons (K), rotate appliance away from you, and allow appliance to rest on the counter. Press tabs and lift to remove the Drip Tray, empty liquid, clean Drip Tray and replace in housing. When replacing drip tray, set the right end of the drip tray into place, then firmly snap both sides down. Appliance can be used without Drip Tray, however the Adjustable Food Sensor setting ② will not function without the Drip Tray.

Clean Upper Bag Detection Tray after each use. The Upper Bag Detection Tray (P) is removable for cleaning, remove by lifting the tabs on each end. Do not pull on the Upper Bag Detection Flags to remove the Upper Bag Detection Tray. Clean Upper Bag Detection Tray by washing in warm soapy water or placing in top rack of dishwasher. Upper Bag Detection Tray MUST be inserted to use the appliance. Without the Upper Bag Detection Tray, your FoodSaver® Appliance will not detect a bag when inserted in the Vacuum Channel (E).

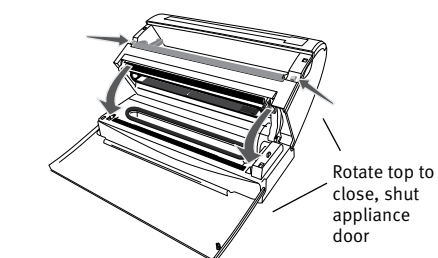
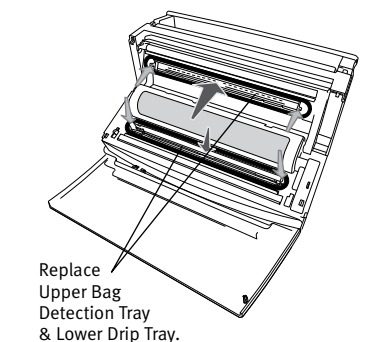
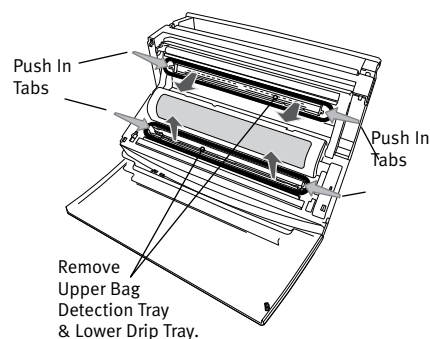

Marinating with your FoodSaver® Appliance

Your FoodSaver® Vacuum Sealing System has a special Quick marinate Cycle which will last about ten minutes. The FoodSaver® Quick Marinator Canister is the perfect FoodSaver® accessory for marinating foods.

During the Marinate Cycle, the vacuum pump will “hold” the vacuum for several minutes then release the vacuum

Allowing the food to “rest” for 30 seconds. This process then repeats. This “Pulsing” action of “vacuuming and resting” will allow for quicker more flavorful marinating.

Important Note: Use the FoodSaver® during the Quick Marinate Cycle, make sure knob on lid of the Quick Marinating Canister accessory is set to OPEN. **Do not set knob to Vacuum during the Marinate Cycle.**

1. Prepare enough of your favorite marinade to fully cover food inside a marinating canister.

Always leave at least one inch (2.54 centimeters) of space between contents and top of rim.

2. Make sure rubber gasket underneath lids as well as rim of marinating canister is free from food materials.
3. Make sure Accessory Hose (F) is securely inserted into port on the FoodSaver® Quick Marinator lid (Fig. 1).
4. Make sure knob on accessory lid is set to OPEN (Fig. 2).
5. Make sure lid is firmly attached to marinator base.
6. Press Marinate button ③ on the control panel (Fig. 3).
7. Your FoodSaver® Vacuum Sealing System will now begin the Quick Marinate Cycle. The Marinate Indicator Light will flash to indicate the marinating process has begun.
8. During the initial vacuum cycle the Marinate Mode Indicator will illuminate. While Marinating, the Vacuum Progress Display will blink during the Vacuum Hold or Rest Cycle.
9. To preserve food safely, after completing the marinating cycle, the appliance will signal with short beeps to indicate your Quick Marinate Cycle is completed. Press any button to silence the signal. You may now cook or refrigerate your marinated food.
10. To use the Quick Marinating Canister to for extended vacuum storage (beyond the short Marinate Cycle): Rotate knob to Vacuum/Canister position, connect the Accessory hose (as above) and select the Accessory Mode cycle from the control panel. When motor turns off, rotate knob clockwise to the “Closed” position, then gently twist and remove Accessory Hose from accessory.

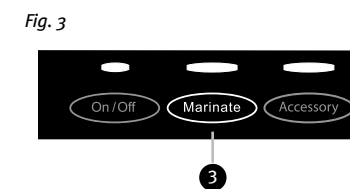
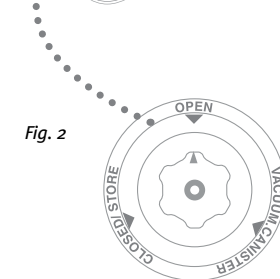
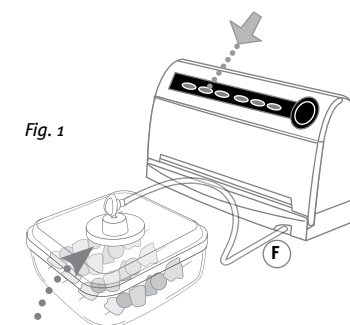
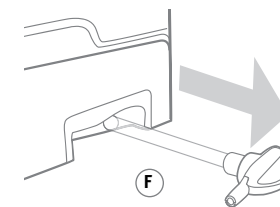

Recipes for your FoodSaver® Appliance

For additional delicious recipes using the FoodSaver® system to prepare foods in advance, check our website, www.foodsaver.com.

Main Street Meatloaf

This meatloaf is a fantastic All-American version of classic meatloaf! Any leftovers can be packaged in a FoodSaver® Vacuum Storage Bag and frozen.

3 Tbsp. unsalted butter	1/2 tsp. dried marjoram
3/4 cup yellow onion, chopped	1/4 tsp. salt
3/4 cup celery, with leaves, chopped	1 tsp. black pepper, freshly ground
1/2 cup carrots, peeled and finely chopped	2 lbs. lean ground beef
1/4 cup fresh parsley, chopped	1/2 lb. ground veal
4 cloves garlic, minced	1/2 lb. ground pork
2 eggs, lightly beaten	3/4 cup plain bread crumbs
1/2 cup light cream	1 Tbsp. Worcestershire sauce
1/2 cup ketchup	1/2 cup tomato sauce
1/2 tsp. ground nutmeg	3 thick slices bacon, uncooked
1/2 tsp. dried thyme	canola oil nonstick cooking spray

Preheat the oven to 375° F. Coat a large rectangular baking dish with cooking spray. In a heavy skillet over medium heat, melt the butter and sauté the onion, celery, carrots, parsley and garlic until softened and the moisture has evaporated, about 10 minutes. Remove from the heat and set aside to cool. In a large bowl, whisk together the eggs, cream, ketchup, nutmeg, thyme, marjoram, salt and pepper. To the egg mixture, add the meats, bread crumbs and cooled vegetables, mixing thoroughly with a wooden spoon or your hands. Form the mixture into a large oval and place in the baking dish. Mix the Worcestershire sauce into the tomato sauce and spoon over the top of the meatloaf. Place the bacon slices lengthwise over the tomato sauce. Place the pan on the middle rack in the oven and bake for 45 minutes.

Remove from the oven, loosely cover and allow to rest for 15 minutes before slicing. Serve immediately or seal and freeze as needed.

Serves 8 or makes 2 meals of 4 servings each.

Grilled Tarragon Mustard Chicken

Tender grilled chicken, marinated in the FoodSaver® Quick Marinating Canister, is a perfect foundation for any meal!

3 lbs. boneless, skinless, chicken breast halves (about 8 pieces)	1 Tbsp. lowfat margarine
1 cup Tarragon Mustard Marinade (below), divided	1/2 cup dry white wine

Prepare a charcoal or gas grill to medium high heat. Place the chicken breasts in the FoodSaver® Quick Marinating Canister, cover with 1/2-cup marinade and vacuum seal. Marinate for 20 minutes. Remove the chicken from the canister and discard the marinade. Lightly wipe the grill rack with cooking oil. Place the chicken breasts on the grill and cook over medium-high heat until well browned, about 6 to 8 minutes. Turn the chicken and cook until the meat is no longer pink and the internal temperature reaches 170° F on an instant read thermometer. When the chicken is pierced with a fork, the juices should run clear. While the chicken is grilling, melt the margarine in a medium sauté pan over medium heat. Add the remaining marinade and wine and bring to a boil. Cook the sauce at a high simmer, stirring constantly until slightly thickened. Reduce the heat to low and simmer another 4 minutes. To serve, place 4 grilled chicken pieces on a platter and ladle the sauce over each. Serve immediately.

Makes 4 servings.

Cool the remaining 4 grilled chicken breasts, separate into individual portion control sizes, vacuum seal and freeze.

Tarragon Mustard Vinaigrette

3 Tbsp. champagne vinegar	1/2 tsp. salt
1 Tbsp. Dijon mustard	1/2 tsp. black pepper, freshly ground
1 tsp. lemon juice	3/4 cup extra-virgin olive oil
1 tsp. dried tarragon	

In a small bowl, whisk together the vinegar, mustard, lemon juice and spices, until blended. Drizzle in the olive oil, whisking constantly, until thoroughly blended.

Makes 1 cup.

Smoky Tomato, New Potato & Fresh Pea Stew

Use handy FoodSaver® Vacuum Storage Bags to freeze pre-chopped onions, garlic, potatoes, tomatoes and parsley. Makes dinner time a snap to prepare!

1 Tbsp. extra-virgin olive oil	½ tsp. bottled liquid smoke flavoring
1 cup yellow onion, chopped	4 medium beefsteak tomatoes, chopped
1 clove garlic, minced	1 ½ cups fresh peas, (you may substitute frozen, thawed peas)
1 ½ lbs. new red potatoes, unpeeled, diced	1 Tbsp. fresh parsley, minced
4 cups Oregano & Garlic Tomato Sauce (below)	salt and pepper to taste
1 cup water	

In a large stockpot, heat the olive oil over medium heat. Sauté the onion and garlic in the oil until the onion is soft. Add the potatoes, Oregano & Garlic Tomato Sauce, water and liquid smoke flavoring. Bring the stew to a boil, reduce the heat to low and simmer for 30 minutes, or until the potatoes are tender. Add the tomatoes, peas, parsley and salt and pepper to taste. Stir to combine, cover and simmer until the peas are just tender.

Oregano & Garlic Tomato Sauce

Use this flavorful sauce immediately or pre-freeze and vacuum seal in a FoodSaver® Vacuum Storage Bag for easy reheating.

3 Tbsp. extra-virgin olive oil	3 cups water
2 medium yellow onions, chopped	1 tsp. sugar
2 cloves garlic, minced	¾ tsp. salt
3 28 oz. cans whole peeled tomatoes	¾ tsp. dried oregano
3 cups tomato sauce (15 oz. can plus 8 oz. can)	½ tsp. black pepper, freshly ground
5 Tbsp. canned tomato paste	

In a large, heavy saucepan, heat the olive oil over medium heat. Add the onions and garlic and sauté until softened, about 5 minutes. In a large bowl, crush the tomatoes and add to the saucepan with the remaining ingredients. Stir well to blend, reduce the heat to simmer and cook uncovered for 45 minutes, stirring occasionally, reducing and slightly thickening the sauce.

Makes 16 cups (4 quarts).

Grilled Far East Salmon Fillets

Use the FoodSaver® Quick Marinating Canister for quick results in marinating these fillets to perfection.

4 6-oz. salmon fillets	2 stalks lemongrass, cut in half
1 Cup Far East Marinade (below), divided	1 red onion, skin removed, and quartered

Place the fillets in the Quick Marinating Canister with ½-cup marinade, vacuum seal and marinate for at least 20 minutes. Prepare a gas or charcoal grill for medium heat. Remove the salmon and discard the marinade. Place the salmon fillets on the grill with a piece of lemongrass on each fillet. Place an onion quarter beside each fillet. Cover the grill and cook for 6 minutes. Turn the fillets over and brush with the remaining ½-cup marinade. Turn the onion quarters and place the lemongrass on top of each fillet. Cover and cook another 4 to 6 minutes, until the fish flakes easily. To serve, plate each fillet with a piece of lemongrass on top and the grilled quartered onion beside the fillet.

Serves 4.

Far East Marinade

½ cup dry sherry	2 Tbsp. fresh ginger, grated
½ cup soy sauce	2 Tbsp. fresh garlic, minced
¼ cup rice wine vinegar	1 Tbsp. sugar
¼ cup sake or rice wine	1 Tbsp. fresh cilantro, chopped
2 Tbsp. sesame oil	1 tsp. hot Asian chile paste

Whisk all ingredients in a medium bowl until well blended.

Makes 2 cups; enough for 6 pounds of chicken, beef, pork, shrimp or fish.

Trouble-Shooting

Problem	Solution
Red Seal LED Flashing	<ul style="list-style-type: none"> • Bag not inserted properly. Remove bag, wait for red light to stop flashing re-insert bag • Wait 20 seconds between seals. • Unit overheated. Wait several minutes for unit to cool down.
Vacuum Pump is running, but bag is not evacuating	<ul style="list-style-type: none"> • If making a bag from a roll, make sure one end of bag is sealed- See How to make a bag from a FoodSaver® Vacuum Sealing Roll. • Open unit and make sure there are no foreign objects, dirt or debris on the top or bottom gasket (See Care and Cleaning pg. 15).
Bag is not sealing properly	<ul style="list-style-type: none"> • Too much liquid in bag, freeze before vacuuming. • To prevent wrinkles in the seal, gently stretch bag flat while inserting bag into vacuum channel and continue to hold bag until vacuum pump starts.
No lights on the control panel	<ul style="list-style-type: none"> • Make sure unit is plugged in. • Make sure wall outlet is functional. • Press on/off button.
Nothing happens when bag is inserted	<ul style="list-style-type: none"> • Make sure unit has power (see above). • Tray Full- empty drip tray. Clean Drip Tray and replace in housing. (See Care and Cleaning pg. 15). • Make sure Upper Bag Detection Tray is in place (See page 4 diagram). • Too much food in bag. Avoid overfilling. Allow 3 inches (7.62cm) space between contents and top of bag. • Bag not inserted correctly. Insert bag CURL DOWN. Gently stretch bag flat while inserting. Hold bag until Vacuum Pump starts.
Moist LED Flashing	<ul style="list-style-type: none"> • Drip Tray has liquid or Drip Tray may be dirty. Empty liquid, clean Drip Tray and replace in housing (See Care and Cleaning pg. 15).
If you need further assistance:	<ul style="list-style-type: none"> • Call Consumer Services at 1-877-777-8042. • For additional tips and answers to frequently asked questions, go to www.foodsaver.com/Support.aspx

1 Year Limited Warranty

Sunbeam Products, Inc. doing business as Jarden Consumer Solutions or if in Canada, Sunbeam Corporation (Canada) Limited doing business as Jarden Consumer Solutions (collectively "JCS") warrants that for a period of one year from the date of purchase, this product will be free from defects in material and workmanship. JCS, at its option, will repair or replace this product or any component of the product found to be defective during the warranty period. Replacement will be made with a new or remanufactured product or component. If the product is no longer available, replacement may be made with a similar product of equal or greater value. This is your exclusive warranty. Do NOT attempt to repair or adjust any electrical or mechanical functions on this product. Doing so will void this warranty.

This warranty is valid for the original retail purchaser from the date of initial retail purchase and is not transferable. Keep the original sales receipt. Proof of purchase is required to obtain warranty performance. JCS dealers, service centers, or retail stores selling JCS products do not have the right to alter, modify or any way change the terms and conditions of this warranty.

This warranty does not cover normal wear of parts or damage resulting from any of the following: negligent use or misuse of the product, use on improper voltage or current, use contrary to the operating instructions, disassembly, repair or alteration by anyone other than JCS or an authorized JCS service center. Further, the warranty does not cover: Acts of God, such as fire, flood, hurricanes and tornadoes.

What are the limits on JCS's Liability?

JCS shall not be liable for any incidental or consequential damages caused by the breach of any express, implied or statutory warranty or condition.

Except to the extent prohibited by applicable law, any implied warranty or condition of merchantability or fitness for a particular purpose is limited in duration to the duration of the above warranty.

JCS disclaims all other warranties, conditions or representations, express, implied, statutory or otherwise.

JCS shall not be liable for any damages of any kind resulting from the purchase, use or misuse of, or inability to use the product including incidental, special, consequential or similar damages or loss of profits, or for any breach of contract, fundamental or otherwise, or for any claim brought against purchaser by any other party.

Some provinces, states or jurisdictions do not allow the exclusion or limitation of incidental or consequential damages or limitations on how long an implied warranty lasts, so the above limitations or exclusion may not apply to you.

This warranty gives you specific legal rights, and you may also have other rights that vary from province to province, state to state or jurisdiction to jurisdiction.

How to Obtain Warranty Service

In the U.S.A.

If you have any question regarding this warranty or would like to obtain warranty service, please call 1.800.777.5452 and a convenient service center address will be provided to you.

In Canada

If you have any question regarding this warranty or would like to obtain warranty service, please call 1.800.804.5383 and a convenient service center address will be provided to you.

In the U.S.A., this warranty is offered by Sunbeam Products, Inc. doing business as Jarden Consumer Solutions located in Boca Raton, Florida 33431. In Canada, this warranty is offered by Sunbeam Corporation (Canada) Limited doing business as Jarden Consumer Solutions, located at 20 B Hereford Street, Brampton, Ontario L6Y 0M1. If you have any other problem or claim in connection with this product, please write our Consumer Service Department.

PLEASE DO NOT RETURN THIS PRODUCT TO ANY OF THESE ADDRESSES OR TO THE PLACE OF PURCHASE.